

# DM Idea



Scroll saw patterns & Woodworking plans

## Paint Brush Holder



[www.dmidea.eu](http://www.dmidea.eu)

DM Idea -YouTube

danielmiskoidea@gmail.com



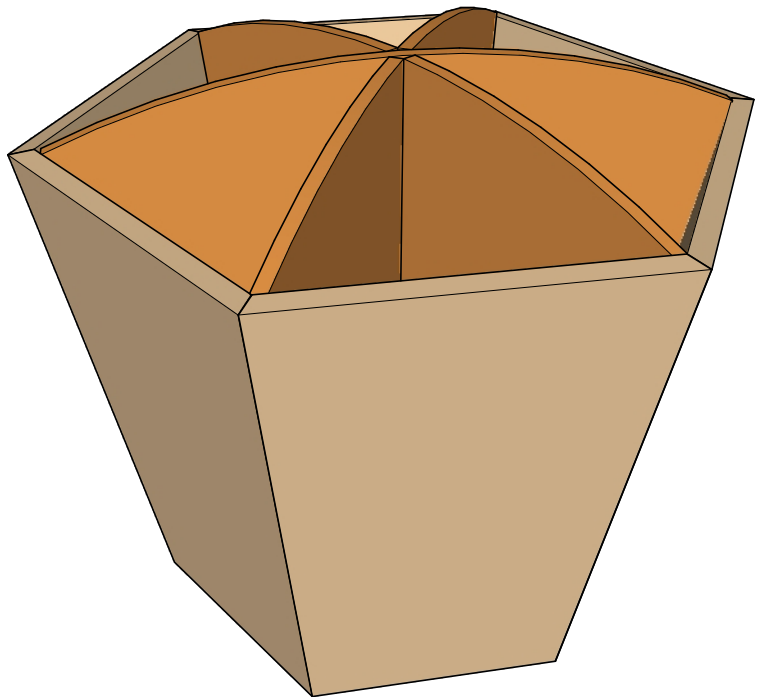
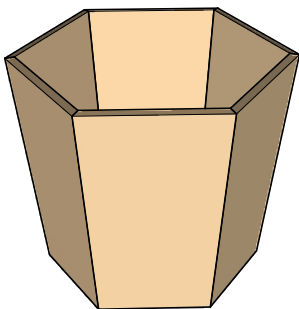
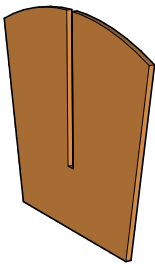
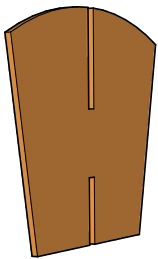
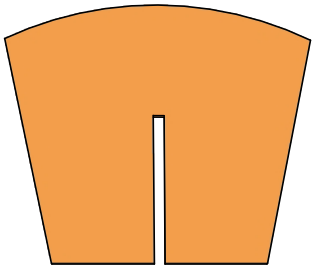
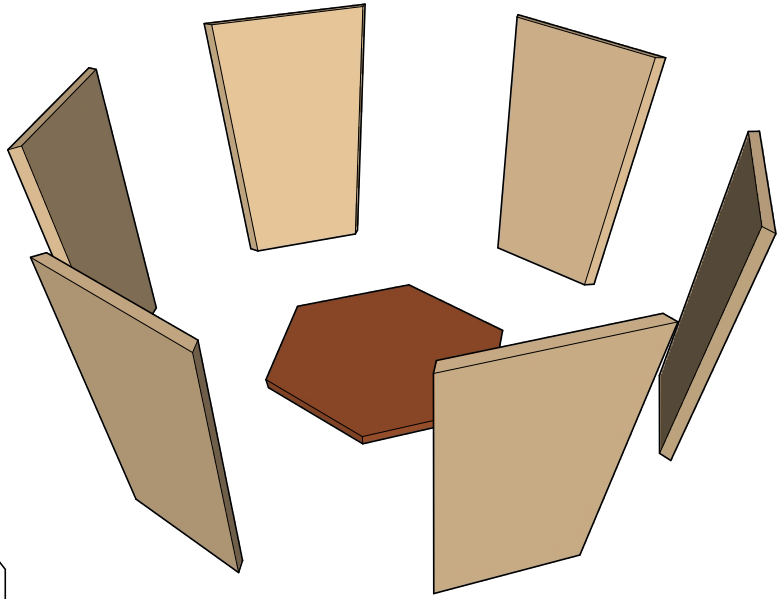

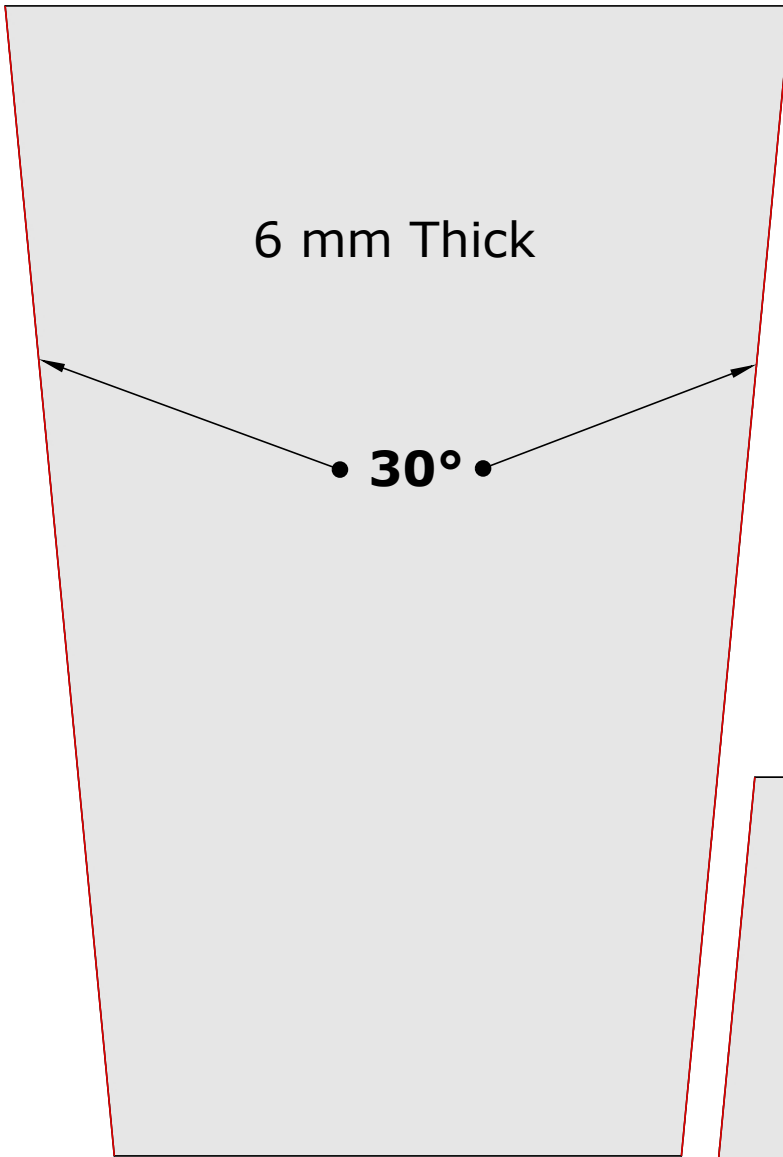

# Angled cuts !

**Tilt your scroll saw table to the left.**

**Red line -**  
**-run the workpiece**  
**on the left**  
**side of the blade.**

